



KS 40-1 / 41-1/ 42-1 Universal Industrial Controller



BluePort® Front interface and BlueControl Software

Maintenance manager and error list

Three DIN sizes

Automatic/Manual key

Monitoring of heating current and input circuit

Timer and programmer

Extended limit signalling function with latch

Type tested to DIN 3440, cUL and GL

universal line

- ⊕ Universal continuous/switching version, i.e. reduced stocks
- ⊕ 100 ms cycle time, i.e. also suitable for fast control loops
- ⊕ Customer-specific linearization for all sensors
- ⊕ Freely configurable analog output, e.g. as process value output
- ⊕ Settings can be blocked via password and internal switch for high security
- ⊕ Extended temperature range up to 60 °C allows mounting close to the process
- ⊕ Easy 2-point or offset measurement correction
- ⊕ Emergency operation after sensor break by means of the „output hold“ function
- ⊕ Logical combination of digital outputs, e.g. for general alarm
- ⊕ Programmer with 4 segments and „end“ signal
- ⊕ RS 422/485 Modbus RTU interface
- ⊕ Built-in transmitter power supply
- ⊕ Splash-water proof front (IP 65)

APPLICATIONS

- Furnaces and ovens
- Burners and boilers
- Plastics processing
- Driers
- Climatic chambers
- Heat treatment plants
- Sterilizers

DESCRIPTION

The universal temperature controller KS 4X-1 are intended for universal, precise, and cost-effective control tasks in all branches of industry. For this, the unit provides simple 2-point (on/off) control, continuous PID control, or 3-point stepping control. The process value signal is connected via a universal input. A supplementary analog input can be used for heating current measurement or as an external set-point input.

Every KS 4X-1 has three process outputs that can be 3 relays or 2 relays plus a universal output. This universal output can be used for operating a solid-state relay, a continuous current/voltage output or to energize a two-wire transmitter.

Plug-in module

KS 4X-1 controllers are built as plug-in modules. This enables them to be replaced very quickly without tools, and without disturbing the wiring.

Self-tuning

During start-up, the self-tuning function determines the optimum settings for fast line-out without overshoot. With three-point controller configuration, the „cooling“ parameters are determined separately, thus ensuring an optimum match to the process.

Display and operation

Clear informations are given by ten indicator LED's in the front panel that display operating mode, I/O states, and errors. The auto/manual key switches the controller into the manual mode directly, without lengthy operating sequences. If required, the direct switch over can be disabled or the key can be configured e.g. to start the internal timer. This results in a level of operational safety that is usually found only in controllers of a higher price category.

Front interface and Engineering Tools

Control parameter adjustment in seconds has now also been implemented in the KS 40 class of instruments. Via the BlueControl software incl. its simulation functions, and especially the convenient BluePort front panel interface, the required set-up for a specific control task can be determined without a detailed study of the operating instructions.

Off course almost all adjustments can be done comfortably over the instrument front. (see page 6, BlueControl)

Password protection

If required, access to the various operating levels can be protected with a password. Similarly, access to a complete level can be blocked.

TECHNICAL DATA

INPUTS

SURVEY OF THE INPUTS

Input	Used for:
INP1	x (process value)
INP2	Heating current, ext. set-point
di1	Operation disabled, switch-over to second set-point SP.2, external set-point SP.E, fixed output signal Y2, manual operation, controller off, disabled auto/manual key, reset stored alarms, timer start (Δ Y2)
di2 (option)	
di3 (option)	

PROCESS VALUE INPUT INP1

Resolution: > 14 bits
 Decimal point: 0 to 3 decimals
 Digital input filter: adjustable 0,000...9999 s
 Scanning cycle: 100 ms
 Measured value correction: 2-point or offset correction

Thermocouples (Table 1)

Input impedance: $\geq 1 \text{ M}\Omega$
 Effect of source resistance: $1 \mu\text{V}/\Omega$

Cold junction compensation

Max. additional error 0,5 K

Sensor break monitoring

Sensor current: $\leq 1 \mu\text{A}$
 Operating sense configurable (see page 4)

Resistance thermometer

Connection: 3-wire
 Lead resistance: max. 30Ω
 Input circuit monitor: Break and short circuit

Resistance measuring range

The BlueControl software can be used to match the input to the sensor KTY 11-6 (characteristic is stored in the controller).

Physical measuring range: 0...4500 Ω
 Linearization segments 16

Current and voltage signals

Span start, end of span: anywhere within measuring range
 Scaling: selectable -1999...9999
 Linearization: 16 segments, adaptable with BlueControl
 Decimal point: adjustable
 Input circuit monitor: 12,5% below span start (2mA, 1V)

Table 1 Thermocouple ranges

Thermocouple		Range		Accuracy	Resolution ()
L	Fe-CuNi (DIN)	-100...900 °C	-148...1652 °F	$\leq 2 \text{ K}$	0,1 K
J	Fe-CuNi	-100...1200 °C	-148...2192 °F	$\leq 2 \text{ K}$	0,1 K
K	NiCr-Ni	-100...1350 °C	-148...2462 °F	$\leq 2 \text{ K}$	0,2 K
N	Nicrosil/Nisil	-100...1300 °C	-148...2372 °F	$\leq 2 \text{ K}$	0,2 K
S	PtRh-Pt 10%	0...1760 °C	32...3200 °F	$\leq 2 \text{ K}$	0,2 K
R	PtRh-Pt 13%	0...1760 °C	32...3200 °F	$\leq 2 \text{ K}$	0,2 K
	special	-25 ...75 mV		$\leq 0,1 \%$	0,01 %

Table 2 Resistance transducers

Type	Sensor current	Range		Accuracy	Resolution ()
Pt 100	0,2mA	-200...100 (150)°C	-328...212 (302)°F	$\leq 1 \text{ K}$	0,1 K
Pt100		-200...850 °C	-328...1562 °F	$\leq 2 \text{ K}$	0,1 K
Pt1000		-200...850 °C	-328...1562 °F	$\leq 2 \text{ K}$	0,1 K
Resistance		4500 Ω		$\leq 0,1 \%$	0,01 %

* The characteristic of a KTY 11-6 is preadjusted (-50...150°C)

Table 3 Current and voltage

Range	Input resistance	Accuracy	Resolution ()
0-10 Volt	110 k Ω	$\leq 0,1 \%$	0,6 mV
0-20 mA	49 Ω (voltage requirement $\leq 2,5 \text{ V}$)	$\leq 0,1 \%$	1,5 μA

Electrical connections:

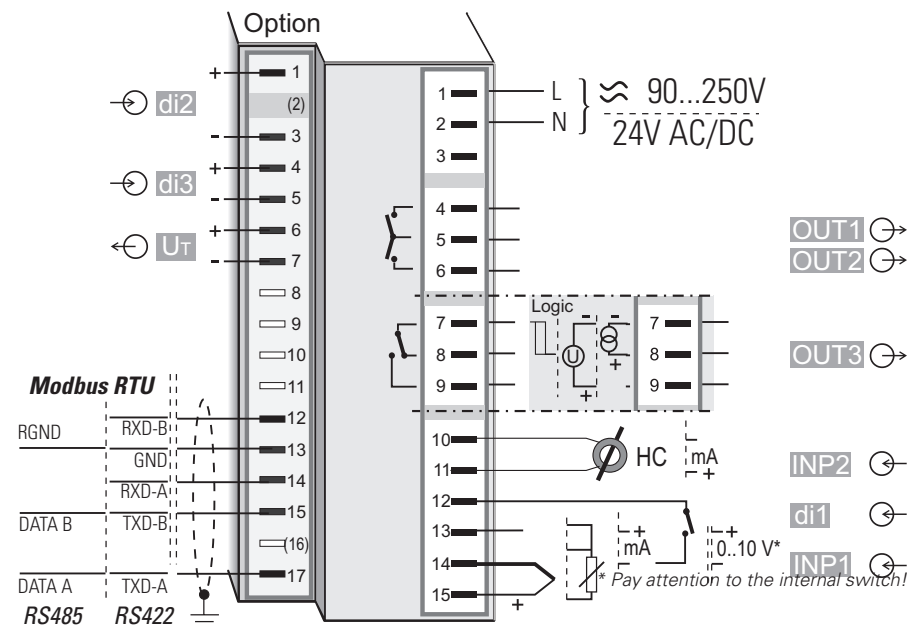

Dimensions (mm):

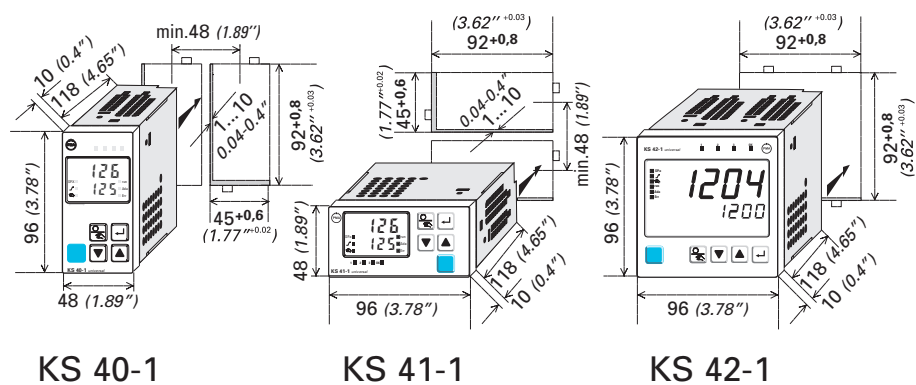

SUPPLEMENTARY INPUT INP2

Resolution: > 14 bit
 Scanning cycle: 100 ms
 Accuracy: better 0,1 %

Heating current measurement

via current transformer

Measuring range: 0...50 mA AC
 Scaling: adjustable -1999..0,000..9999 A

Current measurement range

Input resistance approx. 120 Ω
 Span: configurable within 0 to 20mA
 Scaling: adjustable -1999...9999
 Input circuit monitor: 12,5% below span start (4..20mA 2mA)

CONTROL INPUT DI1

Configurable as direct or invers switch or push-button !

Connection of a potential-free contact suitable for switching „dry“ circuits.

Switched voltage: 2,5 V
 Switched current: 50 μA

CONTROL INPUTS DI2, DI3 (OPTION)

Configurable as switch or push-button !
 Optocoupler input for active triggering

Nominal voltage: 24 V DC, external
 Current sink (IEC 1131 Type 1)
 Logic „0“: -3...5 V
 Logic „1“: 15...30 V
 Current requirement: approx. 5 mA

TRANSMITTER SUPPLY U_t (OPTION)

Output: 22 mA / ≥ 18 V

If the universal output OUT3 is used there may be no external galvanic connection between measuring and output circuits!

OUTPUTS

SURVEY OF THE OUTPUTS

Output	Used for:
OUT1 OUT2 (relay)	Control output heating/cooling or Open/Close, limit contacts, alarms, timer or programmer End *
OUT3 (Relay or logic)	as OUT1 and OUT2
OUT3 (continuous)	Control output, process value, set-point, control deviation, transmitter supply 13 V / 22 mA

* All logic signals can be OR-linked !

RELAY OUTPUTS OUT1, OUT2

Contacts: 2 NO contacts with common connection
 Max. contact rating: 500 VA, 250 VAC, 2A at 48...62 Hz, resistive load
 Min. contact rating: 6 V, 1 mA DC
 Duty cycle electric for I = 1A/2A: ≥ 800,000 / 500,000 (at ~ 250V / (resistive load))

OUT3 USED AS RELAY OUTPUT

Contacts: Potential-free changeover contact
 Max. contact rating: 500 VA, 250 VAC, 2A at 48...62 Hz, resistive load
 Min. contact rating: 5 V, 10 mA AC/DC
 Duty cycle electric for I = 1A/2A: ≥ 1,000,000 / 600,000 (at ~ 250V / (resistive load))

Note:

If the relays OUT1...OUT3 operate external contactors, these must be fitted with RC snubber circuits to manufacturer specifications to prevent excessive switch-off voltage peaks.

OUT3 AS UNIVERSAL OUTPUT

Galvanically isolated from the inputs.

Freely scalable
 DA-converter limiting frequency T₉₀: 50 ms
 Limiting frequency of the complete continuous controller: > 2 Hz
 Resolution: 11 bits

Current output

0/4...20 mA, configurable.
 Signal range: 0...approx. 21,5 mA
 Load: ≤ 500 Ω
 Load effect: 0,02 % / 100 Ω
 Resolution: ≤ 22 μA (0,1 %)
 Error: ≤ 40 μA (0,2 %)

Galvanic isolations:

— Safety isolation
 = Functional isolation

Mains supply	Process value input INP1 Supplementary input INP2 Digital input di1
Relay outputs OUT1,2	RS 422/485 interface
Relay output OUT3	Digital inputs di2, 3
	Universal output OUT3 Transmitter supply UT

Example of the linkage of the internal functions:

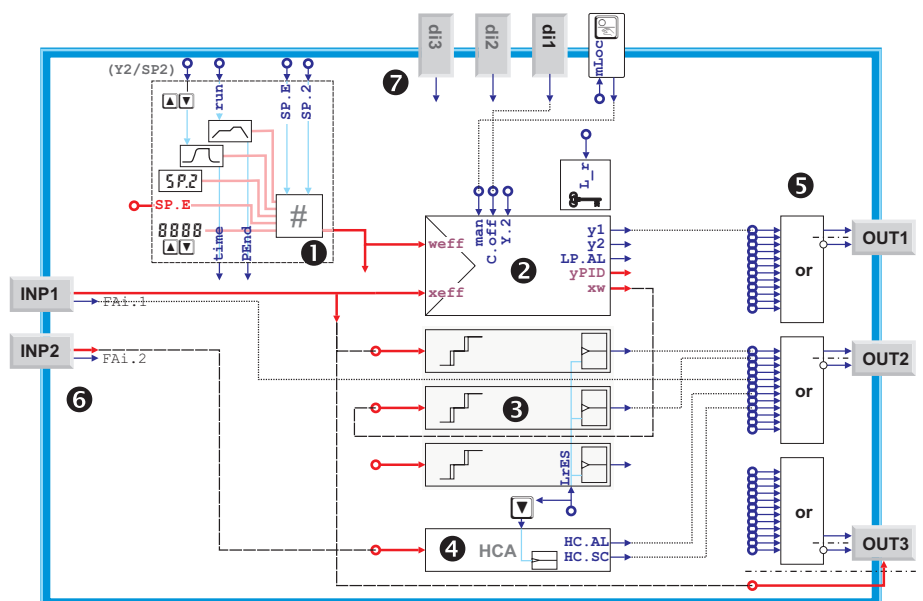

- 1 setpoint processing with programmer and timer
- 2 controller function with loop monitoring
- 3 limit monitoring, configurable with latch and suppression
- 4 heating current monitoring
- 5 output processing with logic or-combination and inverting
- 6 analog inputs with logical sensor fail signal
- 7 digital inputs and keypad with lock function

Voltage output

0/2...10V, configurable	
Signal range:	0...11 V
Load:	≥ 2 kΩ
Load effect:	no Effect
Resolution:	≤ 11 mV (0,1%)
Error:	≤ 20 mV (0,2%)

OUT3 used as transmitter supply

Output: 22 mA / ≥ 13 V

OUT3 used as logic output

Load ≤ 500 Ω	0/≤ 20 mA
Load > 500 Ω	0/> 13 V

FUNCTIONS

Control behaviour

- Signaler with adjustable switching differential (ON/OFF controller)
- PID controller (2-point and continuous)
- Delta / Star / Off or 2-point controller with switch over from partial to full load
- 2 x PID (heating/cooling, 3-point and continuous))
- 3-point stepping controller

Self-tuning control parameters or adjustable manually via front keys or BlueControl software.

Set-point functions

- Adjustable set-point gradient 0,01...9999 °C/min
- Set-point control
- Set-point/cascade control
- Program controller with 4 segments (set-point/section time)
- Timer

Timer

Time $t.SP$ adjustable from 0,1 to 9999 min

Timer Start:

- Mains on
- Control input
- -key (ΔY2 switch-over)
- Direct adjustment of running time

Behaviour with sensor break or short circuit:

- Control outputs switched off
- Switch-over to a safe output value
- Switch-over to a mean output value

LIMIT SIGNALLING FUNCTIONS

Max., Min. or Max./Min. monitoring with adjustable hysteresis.

Signals which can be monitored:

- Process value
- Control deviation
- Control deviation with suppression during start-up or set-point changes
- Effective set-point
- Output signal Y

Functions

- Input signal monitoring
- Input signal monitoring with latch (reset via front key or digital input)

Several limit signals or alarms can be OR-linked before being output.

Applications: Release of a brake with motor actuators, general alarms, etc.

ALARMS

Heating current alarm

- Overload and short circuit
- Open circuit and short circuit

Limit value adjustable 0...9999 A

Control loop alarm

Automatic detection if there is no response of the process to a change of output value.

Sensor break or short circuit

Depending on selected input type, the input signal is monitored for break and short circuit.

Timer modes 1 and 2

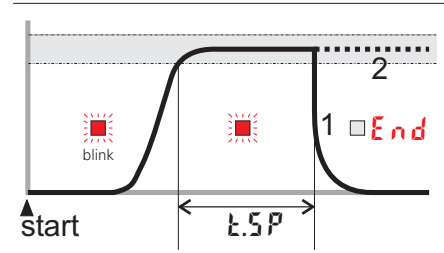

Timer modes 3 and 4

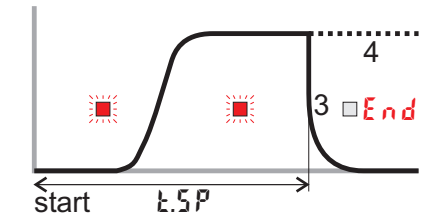

Timer mode 5

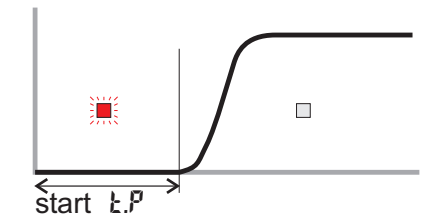

Timer mode 6

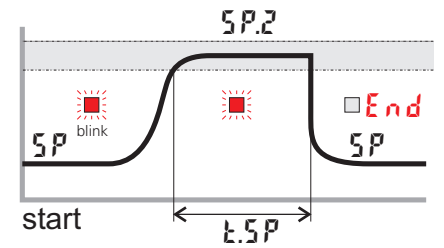

Flashing Error LED indicates active alarm in the error list:



Display and operation:

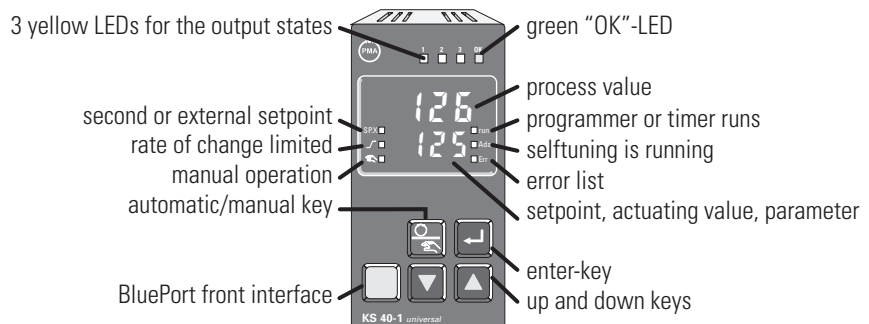

MAINTENANCE MANAGER

Display of error signals, warnings, and latched limit messages in the error list.

Signals are latched, and can be reset manually.

Possible signals in the error list:

Sensor break, short circuit, reversed polarity
Heating current alarm
Control loop alarm
Fault during self-tuning
latched limit messages
e.g. re-calibration warning
(If the adjusted operating hours are exceeded a message is displayed)
e.g. maintenance interval of actuator
(If the adjusted switching cycles are exceeded a message is displayed)
Internal fault (RAM, EEPROM, ...)

OPERATION AND DISPLAY

Display

	KS40-1 / KS41-1	KS42-1
Process value:	10,5 mm LED	19 mm LED
Lower display:	7,8 mm LED	10,5 mm LED

POWER SUPPLY

Depending on version:

AC SUPPLY

Voltage:	90...260 VAC
Frequency:	48...62 Hz
Power consumption	approx. 7 VA

UNIVERSAL SUPPLY 24 V UC

AC voltage:	20,4...26,4 VAC
Frequency:	48...62 Hz
DC voltage:	18...31 V DC
Power consumption:	approx: 7 VA (W)

BEHAVIOUR WITH POWER FAILURE

Configuration, parameters, and adjusted set-points, control mode: Non-volatile storage in EEPROM

BluePort FRONT INTERFACE

Connection of PC via PC adapter (see „Accessories“). The BlueControl software is used to configure, set parameters, and operate the KS 40-1.

BUS INTERFACE (OPTION)

Galvanically isolated	
Physical:	RS 422/485
Protocol:	Modbus RTU

Transmission speed:
2400, 4800, 9600, 19.200 bits/s

Address range: 00...99
Number of controllers per bus: 32
Repeaters must be used to connect more controllers.

ENVIRONMENTAL CONDITIONS

Protection modes

Front panel: IP 65
Housing: IP 20
Terminals: IP 00

Permissible temperatures

For specified accuracy: 0...60°C
Warm-up time: < 15 minutes
Temperature effect: < 100ppm/K
For operation: -20...65°C
For storage: -40...70°C

Humidity

75% yearly average, no condensation

Shock and vibration

Vibration test Fc (DIN 68-2-6)

Frequency: 10...150 Hz
Unit in operation: 1g or 0,075 mm
Unit not in operation: 2g or 0,15 mm

Shock test Ea (DIN IEC 68-2-27)

Shock: 15g
Duration: 11ms

Electromagnetic compatibility

- Complies with EN 61 326-1
- Complies with the immunity requirements for continuous, unattended operation
 - Complies with the emission requirements class B for rural areas
 - Surge disturbances may increase the measurement error

GENERAL

Housing

Material: Makrolon 9415, flame-retardant
Flammability class: UL 94 V0, self-extinguishing
Plug-in module, inserted from the front

Safety tests

Complies with EN 61010-1 (VDE 0411-1):
Over voltage category II
Contamination class 2
Working voltage range 300 VAC
Protection class II

Certifications

Type test to DIN 3440

With certified sensors it can be used in:

- Heat generating plants with outflow temperatures up to 120°C to DIN 4751
- Hot-water plants with outflow temperatures above 110°C to DIN 4752
- Thermal transfer plants with organic transfer media to DIN 4754
- Oil-heated plants to DIN 4755

cUL certification

(Type 1, indoor use)

Electrical connections

Depending on version:

- Flat-pin connectors 1 x 6,3 mm or 2 x 2,8 mm to DIN 46 244
- Screw terminals for conductor cross-section from 0,5 to 2,5 mm²

Mounting

Panel mounting with two fixing clamps at top/bottom or left/right
Close mounting possible

Mounting position: not critical
Weight: 0,27 kg (9.52 oz)

Accessories supplied with unit

Operating instructions
2 fixing clamps

ACCESSORY EQUIPMENT

BlueControl (Engineering Tool)

PC-based program for configuring, setting parameters, and operating (commissioning) the KS 40-1 controller. Moreover, all the settings are saved, and can be printed on demand.

Depending on version, a powerful data acquisition module is available, complete with trend graphics.

Software requirements:

Windows 95/98/NT/2000.

The built-in simulation serves to test the controller settings, but can also be used for general training and observing the interaction between controller and control loop.

Configurations that can only be implemented via the BlueControl software (not via the front-panel keys):

- Customer-specific linearizations
- Enable „forcing“ for inputs/outputs. Forcing allows to write the analog and digital inputs and outputs via Modbus interface.
- Adjustment of limits for operating hours and switching cycles
- Switch-over to 60 Hz mains frequency
- Disable operator actions and operating levels, plus password definition
- Prevent automatic optimization of cycle times T1, T2

Hardware requirements:

A PC adapter (see „Accessories“) is required for connecting the controller.

Updates and demo software can be downloaded from:

www.pma-online.de

ORDERING INFORMATION

	K	S	4	-	1	-	0	0	-	0	0
KS 40-1 (1/8 DIN)	0				↑						
KS 41-1 (1/8 DIN "landscape")	1				↑						
KS 42-1 (1/4 DIN)	2				↑						
Flat-pin connectors	0										
Screw terminals	1										
90..250V AC, 3 relays	0										
24VAC / 18..30VDC, 3 relays	1										
90..250V AC, 2 relays + mA/logic	2										
24VAC / 18..30VDC, 2 relays +mA/logic	3										
no option	0										
RS422/485 + Transmitter power supply +di2, di3	1										
Standard configuration									0		
Configuration to specification									9		
no manual										0	
manual german										D	
manual english										E	
manual french										F	
Standard (CE certified)											0
cUL-certified (with screw terminals only)											U
DIN 3440 certified											D
German Lloyd certified											G

ACCESSORIES

Description	Order no.
Current converter 50A AC	9404-407-50001
PC adapter, for connecting BlueControl software to the BluePort	9407-998-00001
Standard rail adapter	9407-998-00061
Adhesive set of physical dimension labels with 31 different dimensions and 4 empty labels	4012-140-66041
Operating manual	German 9499-040-62718
Operating manual	English 9499-040-62711
Operating manual	French 9499-040-62732
BlueControl Mini	German/English/french www.pma-online.de
BlueControl Basic	German/English/french 9407-999-11001
BlueControl Expert	German/English/french 9407-999-11011

BlueControl, versions and functionality:

FUNCTIONALITY	MINI	BASIC	EXPERT
parameter and configuration setting	yes	yes	yes
controller and loop simulation	yes	yes	yes
download: trnsfer of an engineering to the controller	yes	yes	yes
online mode/ visualization	SIM only	yes	yes
defining an application specific linearization	yes	yes	yes
configuration in the extended operating level	yes	yes	yes
upload: reading an engineering from the controller	SIM only	yes	yes
basic diagnostic functions	no	no	yes
saving data file and engineering	no	yes	yes
printer function	no	yes	yes
online documentation, help	yes	yes	yes
implementation of measurement value correction	yes	yes	yes
data acquisition and trend display	SIM only	yes	yes
wizard function	yes	yes	yes
extended simulation	no	no	yes
programmeditor (KS 90-1prog only)	no	no	yes

**PMA**

Prozeß- und Maschinen- Automation GmbH

P.O. Box 31 02 29

D-34058 Kassel

Tel.: +49 - 561- 505 1307

Fax: +49 - 561- 505 1710

E-mail: mailbox@pma-online.de

Internet: <http://www.pma-online.de>

Your local representative: